

INNOVATIONS 2025

THE NEW ERA OF KITCHEN STYLE

MATRIX800
by **nolte** KÜCHEN



THE NEW ERA OF KITCHEN STYLE



Experience a brand-new dimension of flexibility and individual style in kitchen planning! Our innovations for 2025 represent significant progress in kitchen design and offer even more freedom in planning than ever before. Give your customers kitchens that set new standards in design and beauty: Discover **Matrix 800!**

In addition to Matrix 750 and Matrix 900 we now offer **Matrix 800** with a carcass height of 800 mm. This new option opens up entirely new opportunities for design, storage space and ergonomics. And the best thing is: Even with now three variants, planning remains easy for you – there is no new classification logic, there are no odd dimensions and, last but not least, we have ensured consistency throughout our entire product range.

Our kitchen designs on the following pages present specific examples of the advantages **Matrix 800** has for you when designing kitchens. Moreover, you have an expansion of our complete product range to look forward to. Just for instance, there is VELLUTO, an easy-care anti-fingerprint front in price group 2, available in high-demand natural hues. We have our finger on the pulse of colour trends, too. Lava is a colour that has been growing in popularity. And as we have proven many times before, we don't rest on our laurels: We immediately added this hue to our range of colours for carcasses and finger pulls.

Experience the innovations of 2025 and join us in our journey to **THE NEW ERA OF KITCHEN STYLE!**

Rüdiger Schliekmann

Manfred Wippermann

Heiko Maibach



Our products are made in Germany – and this is officially certified by the German Furniture Industry Association (Verband Deutsche Möbelindustrie e.V.)



The Golden M guarantees certified quality, safety and healthy living.



Winner of Germany's favourite kitchen brand for multiple years running.



We take our responsibility for our environment and future generations seriously. That is why we are particularly proud to present multiple certifications in this field!

MATRIX+

The plus in possibilities

The desire for flexibility and individuality in construction, living and interior design is growing more and more important. We have kept pace with the times and have created innovations that set new standards for kitchen planning. Our decision to expand the previously strictly maintained grid of 750 and 900 mm is based on extensive market analysis and our customers' feedback. The market trend shows increasing demand for an option with a height of 800 mm – the top-selling height in Europe. Moreover, the visual design of kitchens has changed in recent years. Kitchens are increasingly becoming a living space. With our new carcass height, we combine the living space design created by a low plinth with even more storage space.

We have given this expanded range of carcass heights the name **MATRIX+** and can promise that it will offer you and your customers even more flexibility and freedom of design.



DESIGN meets EFFICIENCY

Our new 800 mm base units are more than just another carcass height – they are the next step in the development of our sophisticated system to make kitchen planning simple and efficient for you. Our aim is to fulfil all of your customers' dreams of unique design while giving you as much planning freedom as possible!

By introducing 800 mm high base units, we have made kitchen design even more flexible. This new height permits integration of pull-outs with a height of 400 mm and, for instance, drawers with a height of 200 mm. These options don't just make better use of the available space and offer extra storage space, they also add to the modern look. They combine function with aesthetics – thereby setting a whole new standard for design.

Use this opportunity to offer your customers kitchen solutions that follow the latest trends while also offering exceptional convenience.

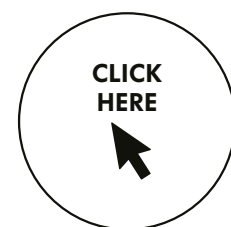

Watch our video to discover **MATRIX+**.





Classic or design-oriented **LAYOUT**

The new added carcass height Matrix800 permits a classic layout with a 150 mm high drawer combined with the new 250 mm and 400 mm high pull-outs or a design-oriented **symmetrical layout** in 400/400 mm, 200/200/400 mm or 200/200/200/200 mm.

Clean and simple **DIMENSIONS**

Moreover, we are maintaining our previous naming scheme for units.

CONSISTENCY without compromises

Like Matrix750 and Matrix900, the new carcass height is available without restrictions, both with handles and as a handleless design as Matrix800 and MatrixArt800, and in nolte**neo** as MatrixArt ONE and MatrixZERO.



More options for INTERIOR ORGANISERS

Two flat drawers can be integrated behind the 200 mm front. In addition, a high interior drawer can be retrofitted in the 400 mm high pull-out. The 400 mm high pull-out is ideal for storing crates of drinks (1.0/1.5 litres). It is also the perfect place to stack interior organiser boxes.

Unchanged RECESS HEIGHT

Nolte kitchens have a special feature: With any of the three carcass heights 750/800/900, the recess height **remains identical at 600 mm** (minus worktop thickness), the standard oven size.

Identical **WALL UNITS**, expanded **APPLIANCE HOUSINGS**

New matching **tall unit heights 2000 mm and 2150 mm** (available with full height door or division 800/1200 or 800/1350). We have also added **highboards with a height of 1600 mm** (available with full height door or division 800/800).

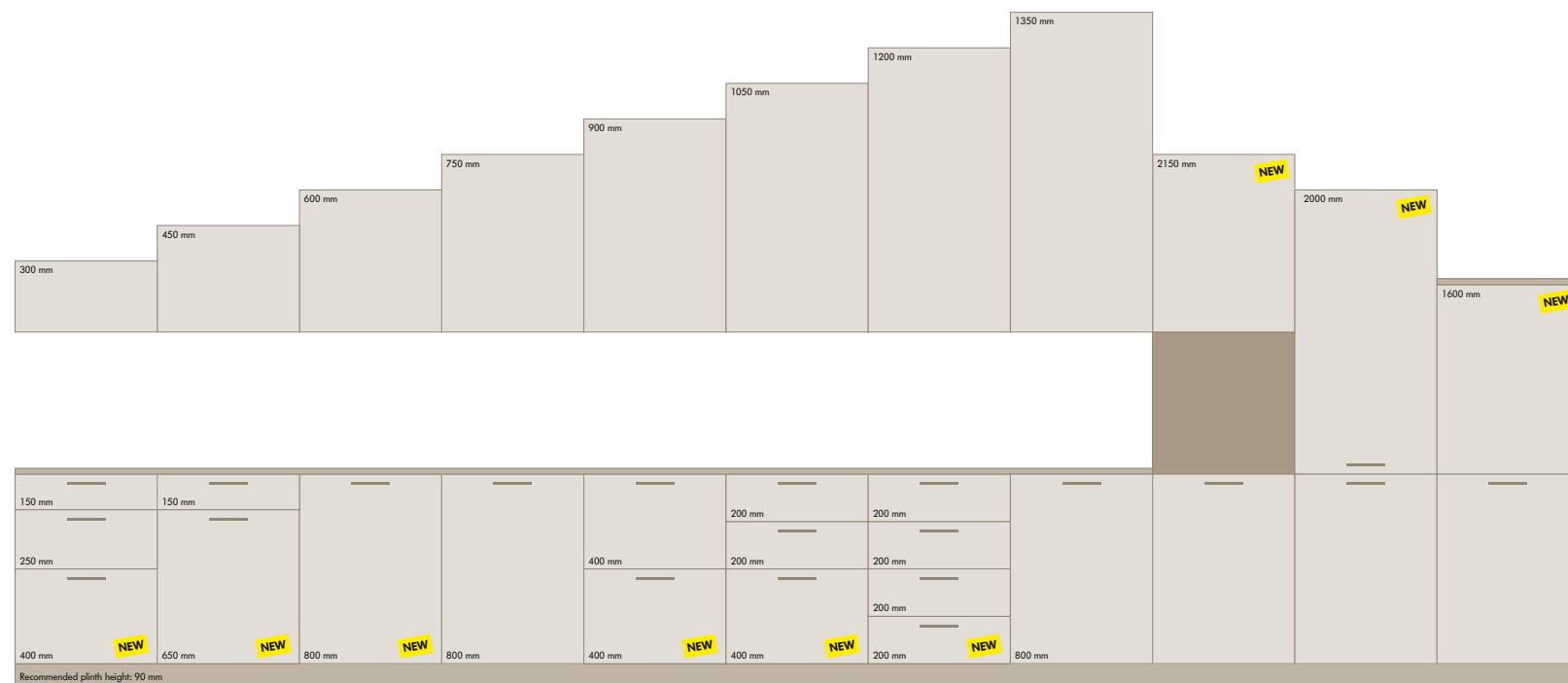

*MatrixZERO units have the same division as Matrix800.

Clean DIVISION – simple DIMENSIONING LOGIC

- Nolte Küchen has its own thoroughly thought through method
- A clear logic of dimensions ensures simple and understandable measurements
- Available for all front ranges**, carcasses, visible sides, etc.
- Available throughout our range and without compromises both with and without handle
- Simple naming as before:
Unit des./width/height/depth (e.g. UAK 60-80-60)
- End panels, pilasters and side panelling have been expanded for all new unit heights
- Combine this with our standard plinth heights
50/70/90/120/150/170 mm and the special plinth heights at 10 mm intervals and you can now design kitchens in any working height with even better ergonomic properties and even more storage space
- The dimensions of all wall units and top-mounted units remain unchanged

** except GLAS TEC



*MatrixArt ONE units have the same division as Matrix800.

No HANDLES – same clean DIVISION

- Changed front division:
150/200/386 mm, 350/386 mm or full height door 768 mm (ideal for more storage space)
- This front division creates a visually identical division above and below the second finger pull
- A connection to the existing 420 mm high MatrixArt units can be made

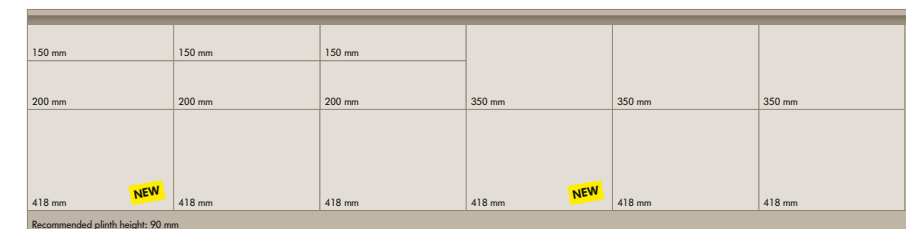



Living

in the kitchen...



Watch our
image film
“Living in the
kitchen”



... is a motto we take literally. We offer everything you need to make your customers' kitchen dreams come true.

Classic, modern or extravagant – we offer solutions for practically any budget and any preference. Our products feature high-quality materials, innovative designs and well-developed functionality. And all of it in tried-and-tested quality – made in Germany.

Discover our new trend kitchens on the following pages and let our ideas inspire you!

VELLUTO Lava mat

VELLUTO 87L - Lava mat • Carcase LAD - Lava
Worktop C30 - White concrete • End panels LAL - Lacquer AFP, lava mat
Handle 845 - Stainless steel look



MATRIX800
by noite KÜCHEN

THE NEW ERA OF KITCHEN STYLE

MODERN MINIMALISM with practical properties

Discover our new VELLUTO range with a mat lacquer surface, shown here in the colour lava. Innovative anti-fingerprint technology keeps the surfaces clean and low-maintenance, a feature that is particularly appreciated by discerning customers. The product range in price group 2 is available in white, lava and graphite mat. The expanded product palette, which now includes lava for the carcase and MatrixArt finger pulls, lets customers design a kitchen all in their preferred colour. Its combination of current trends and advanced technology makes VELLUTO particularly attractive for all those looking for high-quality, low-maintenance, aesthetically appealing kitchen solutions.



Inside and out: With the new lava-coloured carcase, it is now possible to design an entire kitchen looking "like a single piece" in this colour.

Thanks to the new carcase height Matrix800, an additional interior drawer now fits in the 200 mm drawer. This nearly doubles the storage space available for your customers' kitchen utensils.

TREND WOOD OAK still going strong

The new front MANHATTAN Natural oak noble mat in price group 1 is our most recent addition to our range of oak decors. This light-coloured natural oak is a response to current trends and offers a restrained elegance that sets itself apart from rustic grain types. This decor appeals to customers that prefer a calm, elegant look. Natural oak noble mat is combined with a SOFT LACK front in deep blue soft mat. The velvety genuine lacquer surface complements the wood decor while the colour selected in this example adds its own special touch. The bevelled end panels on the sides of the tall units are a particular eye-catcher. Yet another advantage is the added counter, offering space not just to linger and relax, but also for an integrated office space for working from home.



SOFT LACK Deep blue soft mat
MANHATTAN Natural oak noble mat

SOFT LACK 76T - Deep blue soft mat • **MANHATTAN 48T** - Natural oak noble mat • Carcase GTD - Graphite
Worktop E46 - Natural oak noble mat • End panels LMT - Lacquer, deep blue soft mat / NET - Natural oak noble mat
Handle 835 - Manganese bronze

The surrounding area can all be designed in natural oak noble mat, like the countertop in this example.



The bevelled end panels represent an elegant frame for the overall image and offer customers a completely new look. Wall shelves with the same look are also available.



The sink with its subtle natural hue melds seamlessly into the kitchen design.

VELLUTO Graphite mat

VELLUTO 87G Graphite mat • Carcase GTD - Graphite • Worktop M51 - Marble imperiale
End panels LAG - Lacquer AFP, graphite mat / MIE - Marble imperiale • Handle recess profile 591 - Black



THE NEW ERA OF KITCHEN STYLE

CLASSY DESIGN and ingenious highlights

The elegant graphite mat version of the VELLUTO front features an impressively easy-to-clean anti-fingerprint surface. Together with the new carcase height MatrixArt 800 and the black finger pulls, it creates a tidy, highly modern look. This tranquil design is the perfect stage for the new worktop colour marble imperiale: a distinctive stone look in earthy hues. Marble in all of its shades remains an essential element of interior design and adds a special touch to any kitchen. Used for the splashback or the attached counter, this decor is sure to become a conversation piece for your customers.

The combination of VELLUTO in graphite mat and the stone look offers your customers a balanced, fashionable kitchen solution that meets even the highest standards – and does so at an attractive price level, because fashionable design does not need to be expensive.



MATRIXART 800
by notte KÜCHEN

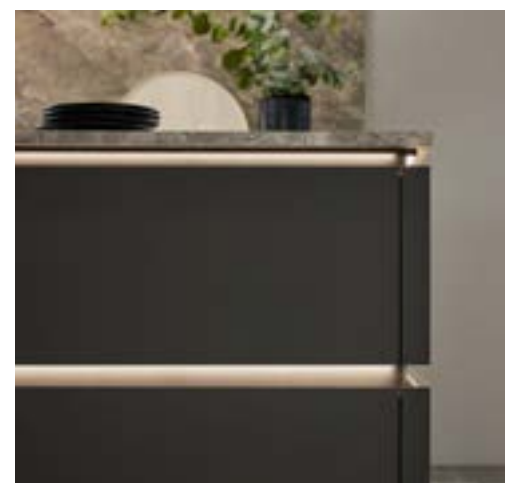

Convenient and space-saving:
The socket with the Qi charger
permits wireless charging,
e.g. of your smartphone.
An extremely practical feature
for a kitchen!

VELLUTO in graphite mat
creates an extremely elegant
look. The anti-fingerprint
surface keeps fingerprints
practically invisible.

Embodies elegance on top:
the worktop in the distinctive
marble imperiale decor.





The integrated LED ring lights provide stylish indirect lighting in the shelf base.

THE NEW ERA OF KITCHEN STYLE

AWARD-WINNING DECOR
to complement the ARTLINE series

ARTLINE, characteristically defined by grooved wooden fronts, now also has a new subtler variant: stripe wood choco. This unconventional design, winner of the German Design Award, is perfect for giving any kitchen a unique look. In this example, the tall units and sideboard offer the perfect surface to highlight the beauty of the decor. The kitchen island in MatrixArt800 adds a subtle charm. With SOFT LACK in muted sepia brown soft mat, it is the ideal counterpart for the distinctive ARTLINE front.

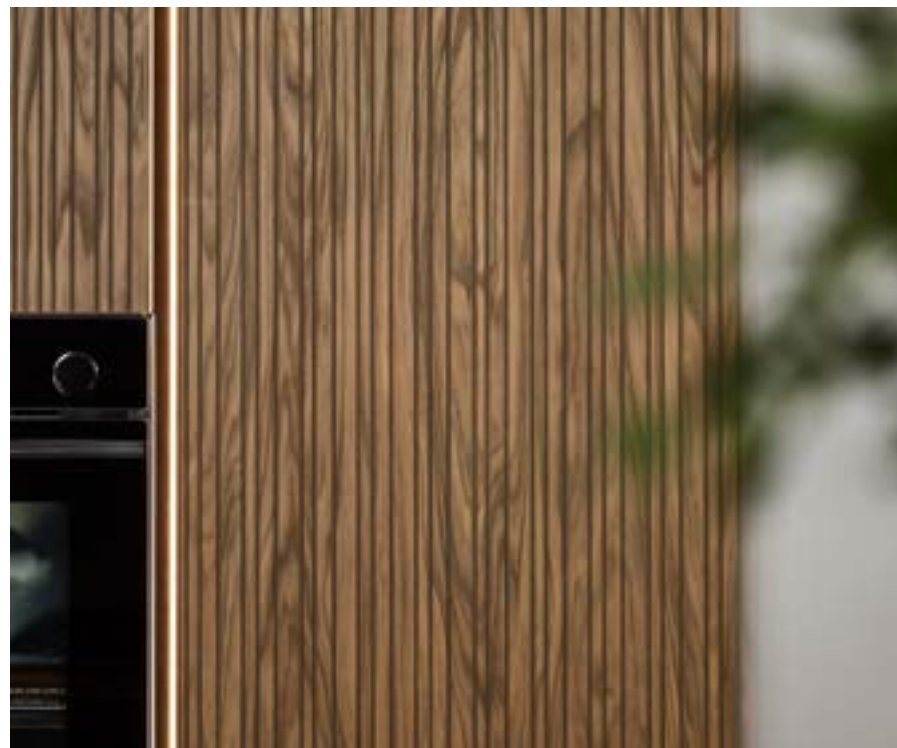

MATRIXART800
by **notteKÜCHEN**

ARTLINE Stripe wood choco
SOFT LACK Sepia brown soft mat

ARTLINE 548 - Stripe wood choco • **SOFT LACK 76U** - Sepia brown soft mat • Carcase GTD Graphite • Ceramic worktop (on site)
End panels LMU - Lacquer, sepia brown soft mat / SCC - Stripe wood choco • Handle recess profile 591 - Black



The exceptional new addition to the ARTLINE collection, stripe wood choco, has already won the German Design Award.

Black rails are the perfect match for the dark worktop that, in its extended variant, turns into a table.





FRAME LACK Magnolia soft mat
TAVOLA Oak pinot

FRAME LACK A02 - Magnolia soft mat • **TAVOLA 571** - Oak pinot
 Carcase AWD - Magnolia / QGD - Quartz grey • Worktop S04 - Jura beige
 End panels LMM - Lacquer, magnolia soft mat / EFP - Oak pinot
 Handle recess profile 791 - Manganese bronze / Handle 835 - Manganese bronze

MATRIXART800
 by nolteKÖCHEN

THE NEW ERA OF KITCHEN STYLE

EXCLUSIVE MATERIALS with coordinated details

The premium-quality effect of this kitchen plan is characterised first and foremost by the use of genuine materials such as wood, glass and genuine lacquer. Our modern framed front **FRAME LACK** magnolia soft mat combines beautifully with **TAVOLA** in oak pinot. **MatrixArt** finger pulls in manganese bronze meld seamlessly into the well-coordinated design of warm natural hues. For added elegance: Glass cases with frames in manganese bronze that complement the overall look. The front division using **MatrixArt800** creates a fully uniform overall design, both above and below the second finger pull.



This pull-out is perfect
 for easily storing
 e.g. crates of drinks.

The tall unit with a width of 750 mm
 offers plenty of storage space for
 e.g. kitchen utensils or supplies.

FRONTS 2025

In addition to expanding our top-selling MANHATTAN UNI range with the colour lava, we are also complementing our oak decor range by adding the new light-coloured front MANHATTAN Natural oak noble mat in price group 1.

Winner of the German Design Award: Our grooved wood fronts of the ARTLINE series now come in another variant: stripe wood choco.

Quality at entry-level prices: The new front range VELLUTO features a mat lacquer surface and state-of-the-art anti-fingerprint technology in price group 2.

PG1
M20 **MANHATTAN UNI**
Melamine resin mat

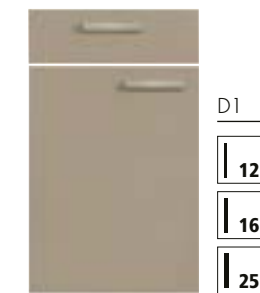

482 Lava

Surrounding elements:
D1 **LAD** Lava
(carcase, plinth, open shelves,
light pelmets/cornice profiles/
end panels)

PG1
M15 **MANHATTAN**
Melamine resin mat

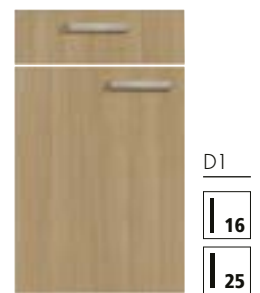

48T Natural oak noble mat

Surrounding elements:
D1 **NET** Natural oak noble mat
(visible sides, plinth, open shelves,
end panels)

PG2
A20 **ARTLINE**
Melamine resin mat

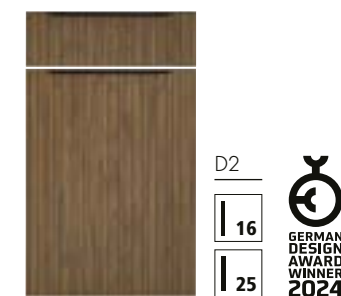

548 Stripe wood choco

Surrounding elements:
D2 **SCC** Stripe wood choco
(end panels)

PG2
V21 **VELLUTO**
Mat lacquer with AFP



87L Lava mat

Surrounding elements:
D2 **LAL** Lacquer AFP, lava mat
(end panels)

PG2
V21 **VELLUTO**
Mat lacquer with AFP



87I White mat

Surrounding elements:
D2 **LAW** Lacquer AFP, white mat
(end panels)

PG2
V21 **VELLUTO**
Mat lacquer with AFP



87G Graphite mat

Surrounding elements:
D2 **LAG** Lacquer AFP, graphite mat
(end panels)

Carcase
LAD Lava



Handle recess profile
792 Lava



Plinth corner
LAD Lava





WORKTOPS 2025

This year we are expanding our range of worktops by a total of 4 new decors. Light-coloured natural oak follows current trends and offers a restrained elegance that sets itself apart from rustic grain types. Marble in all of its shades remains an essential element of interior design and adds a special touch to any kitchen. Galaxy nero represents an expansion of our black product range with a stone look design.



E46 Natural oak noble mat



S08 Galaxy nero



M52 Marble bianco



M51 Marble imperiale

PLANNING with MATRIX800

Matrix 800 offers approx. 3200 new unit types with a size of 800 mm, including base and tall units, highboards and open shelves in the new height. It goes without saying that we have also expanded our range of design elements and surrounding materials, e.g. end panels, pilasters, integrated lighting fixtures or table supports, to match these new options.

This pages shows only some examples. For details, please refer to our current sales manual, where we have added all new features for the new carcass height 800 mm.

Design elements include, for instance:

Lighting



Fitted LED light fixture set for new carcass height 800 mm
2 lights incl. milling cuts in the carcass sides
LED-LKT-80
LED-LKR-80

Rail frame



KU89-60
KU89-60-S
KU89-90
KU89-90-S

Support legs for table attachment



Square tubing
60 x 60 mm

STQ89-6-EST
STQ89-6-S

Round tube
Ø 60 mm

STS89-6-EST

Bevelled end panels in carcass height

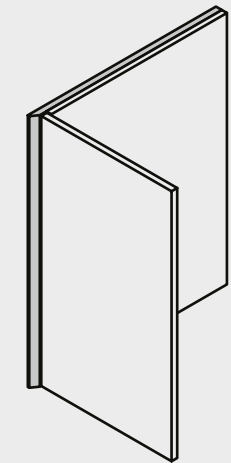

Thickness 19 mm
In carcass height
For all mat lacquer colours (D4)

End panel always protrudes 20 mm at the front in relation to the front

Base units

WF19-ZE 30/45/60/75/80/90-39/60/75

Wall units

WF19-H 30/45/60/75/90/105/115/130/145

Dresser units

WF19-H 115/130/145-60

Tall units and appliance housing units

WF19-ZE 105/135/150/160/195/200/210/215/225-39/60/75

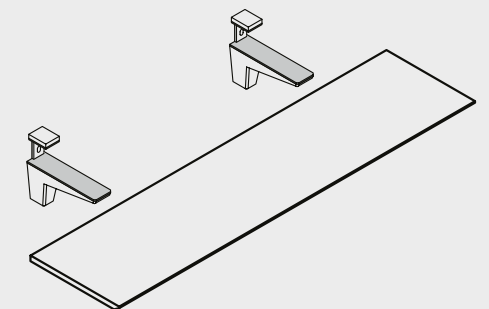

Wall shelves with shelf supports

WSTBF19-BT 2/4-15/25-S (Black)

WSTBF19-BT 2/4-15/25-E (Stainless steel look)

Renaming

The item numbers for the size 25 end panels will change.

WA will become W25

Examples:

OLD		NEW
WA-U75-60	→	W25-U75-60
WA-H60	→	W25-H60
WA-ZE195-60	→	W25-ZE195-60

FITTED SINKS 2025

Nolte Küchen is expanding its range by adding stainless steel sinks by FRANKE and REGINOX, and ELLECI Granitek sinks in three colours. These new sinks offer high quality and combine modern design with simple cleaning and care. Granitek as a material combines an authentic stone look with exceptional resistance properties and an easy-to-clean surface. These innovative products offer more versatility for unique kitchen solutions.

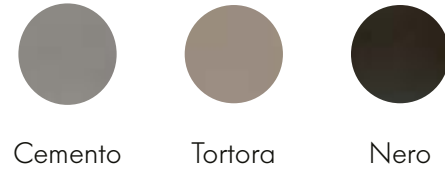

Cemento Tortora Nero



Fitted sink sets



Set consisting of:

Fitted sink with 3 1/2" basket pop-up strainer waste

2 tap holes as knock-outs
cutout dimensions: W x D = 770 x 480 mm

and **mixer tap with swing spray head**
height: 330 mm, projection: 230 mm

SET-E2-45-NE



Set consisting of:

Fitted sink with 3 1/2" basket pop-up strainer waste

3 tap holes as knock-outs
cutout dimensions: W x D = 550 x 480 mm

and **mixer tap with swing spray head**
height: 292 mm, projection: 201 mm

SET-ENK1-60-NE



Set consisting of:

Fitted sink with 3 1/2" basket pop-up strainer waste

3 tap holes as knock-outs
flush-fitted installation only

and **mixer tap with swing spray head**
height: 300 mm, projection: 235 mm

SET-EF1-60-NE

Fitted sinks Granitek

ELLECI fitted sink with 3 1/2" basket pop-up strainer waste
colours: Cemento, Tortora, Nero



3 tap holes as knock-outs
cutout dimensions: W x D = 430 x 480 mm

Surface-mounted
GRA-102L-45-CE/TO/NE
Flush-fitted
GRA-F102L-45-CE/TO/NE



3 tap holes as knock-outs
cutout dimensions: W x D = 550 x 480 mm

Surface-mounted
GRA-105L-45-CE/TO/NE
Flush-fitted
GRA-F10 L-45-CE/TO/NE



2 tap holes as knock-outs
cutout dimensions: W x D = 770 x 480 mm

Surface-mounted
GRA-300L-45-CE/TO/NE



3 tap holes as knock-outs
cutout dimensions: W x D = 840 x 480 mm

Surface-mounted
GRA-410L-60-CE/TO/NE



2 tap holes as knock-outs
cutout dimensions: W x D = 980 x 480 mm

Surface-mounted
GRA-480L-60-CE/TO/NE

Fitted sinks Stainless steel



FRANKE fitted corner sink with 3 1/2" basket pop-up strainer waste

2 tap holes
cutout dimensions: As per template

FRA-SK651-E



FRANKE fitted sink with 3 1/2" basket strainer waste

2 tap holes
cutout dimensions: W x D = 980 x 480 mm

FRA-SK611-60



REGINOX fitted sink with 3 1/2" basket strainer waste and pop-up waste set

2 tap holes
cutout dimensions: W x D = 365 x 495 mm

ESP-NY34-40



REGINOX fitted sink with 3 1/2" basket strainer waste and pop-up waste set

2 tap holes
cutout dimensions: W x D = 520 x 490 mm

ESP-NY50-60



Accessories Waste bins



Waste system behind side-hung door pull-out system

Division in 2

ABF-45-T2



Organiser tray for placing on cover plate

ABF-ORGA20

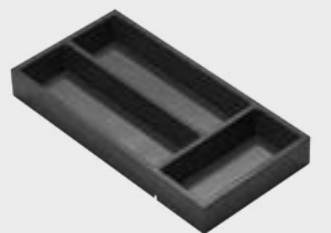



WATER FILTRATION SYSTEM 2025

Simple looks hide sophisticated technology: This new kitchen tap offers normal tap water on one side, but the other side gives you filtered drinking water. Separate water lines allow you to get both water types straight from a single tap. You can enjoy the filtered drinking water in three selectable carbonation levels, still, medium and sparkling/classic, displayed on the integrated LED ring. Based on the selected setting, the cooled sparkling water flows straight from the tap.

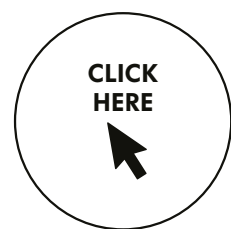

Watch this short video for a presentation of our water filtration system.



Water filtration system Mixer taps



For filtered water

Filter tap
height: 335 mm, projection: 265 mm

MIX-WS800-S (Black)

MIX-WS800-C (Chrome)



For cooled, filtered water with 3 carbonation levels: still, medium, classic

Filter tap
height: 335 mm, projection: 290 mm

Tower
H x W x D = 450 x 210 x 455 mm

MIX-WS810-S (Black)

MIX-WS810-C (Chrome)



Water filtration system Fitted sink sets



Set consisting of:

Fitted sink with 3 1/2" basket pop-up strainer waste

3 tap holes as knock-outs
cutout dimensions: W x D = 430 x 480 mm

and **drinking water filter tap MIX-WS800-S** (Black)

SET-WS-01



Set consisting of:

Fitted sink with 3 1/2" basket pop-up strainer waste

2 tap holes
cutout dimensions: W x D = 365 x 495 mm

and **drinking water filter tap MIX-WS800-C** (Chrome)

SET-WS-02



Set consisting of:

Fitted sink with 3 1/2" basket pop-up strainer waste

3 tap holes as knock-outs
cutout dimensions: H x D = 550 x 480 mm

and **drinking water filter tap with cooling and carbonation MIX-WS810-S** (Black)

SET-WS-11



Set consisting of:

Fitted sink with 3 1/2" basket pop-up strainer waste

2 tap holes
cutout dimensions: W x D = 520 x 490 mm

and **drinking water filter tap with cooling and carbonation MIX-WS810-C** (Chrome)

SET-WS-12

Accessories Plug-and-socket element



EVOLine® One DisQ
Plug-and-socket element with Qi charger

SEONEDQ-F
SEONEDQ-E
SEONEDQ-G



Extension cable with space-saving plug
SEPLUGV-F

Adaptation Plug-and-socket element

EVOLine® BackFlip
Plug-and-socket element with rotating function, dual / 1 x USB C

OLD: **USB-A** → NEW: **USB-C**



ELECTRIC APPLIANCES CANDY 2025

Candy, a Haier group brand, represents European quality and innovative, energy-saving household appliances, 90 % of which are produced in Europe. With modern design, flexible solutions like the sliding hinges for dishwashers,

and attractive value for money, Candy offers 36 appliances and a wide range of accessories that are tailored to customers' needs and perfectly adapted for use in kitchens.

Fitted cooker



HCT 201 X-E
stainless steel, 3 heating methods

HCT 615 X-E
stainless steel, 5 heating methods

HCT 827 XL-E
stainless steel, 7 heating methods

Fitted oven



CA6 NP3T 2HTB
black, 8 heating methods

CA6 NP5B 3YTB
black, 10 heating methods

FCT 600X-E-DE
stainless steel, 7 heating methods

FCT 825XL WIFI
stainless steel, 7 heating methods

Ceramic glass hob linked with cooker



600 mm wide

CUT CE64
frameless, 4 cooking zones

CUT CE64 EXF DF
stainless steel frame, 4 cooking zones,
1 of which is a two-ring cooking zone
1 casserole zone

Ceramic glass hob independent



600 mm wide

CH 64 CCB
frameless, 4 cooking zones

CE H6D XE CTT-1
frameless, 4 cooking zones,
1 of which is a two-ring cooking zone,
1 casserole zone

300 mm wide

CE HDD 30 TCT-1
2 cooking zones,
1 of which is a two-ring cooking zone

Ceramic glass induction hob independent



800 mm wide

CIE S55M CTT-1
frameless, 4 induction cooking zones

600 mm wide

CI 642C BB-1
frameless, 4 induction cooking zones

CTP 64 SC-E1
frameless, 4 induction cooking zones

Wall-mounted, fitted and built-under cooker hoods



Wall-mounted cooker hoods,
900 mm wide

CCE119-1X-DE stainless steel

Wall-mounted cooker hoods
with head space, 900 mm wide

CDG9MBGG-DE black

Wall-mounted cooker hoods,
600 mm wide

CCE116-1X-DE stainless steel

Wall-mounted cooker hoods
with head space, 600 mm wide

CVMAD601N-S-DE black

Fitted cooker hoods,
600 mm wide

CBT625-2X-DE stainless steel

Built-under cooker hoods,
600 mm wide

CFT610-5X-P stainless steel

Microwave appliances



Black, glass

MIC G20G DFB
appliance dimensions:
H x W x D = 382 x 595 x 344 mm

stainless steel

MIC 201 EX
Appliance dimensions:
H x W x D = 382 x 595 x 344 mm

Built-under fridge can be integrated



Aperture height: 820 mm

CM 4SE6 8W
fixed hinge system,
incl. freezer compartment

CM LS68 EW
fixed hinge system

Fridge can be integrated



Aperture height: 880 mm

CM 4S59 EW
sliding hinge system,
incl. freezer compartment

CMLS 59 EW
sliding hinge system

Fridge can be integrated



Aperture height: 1225 mm

CIO 225E E-N
sliding hinge system,
incl. freezer compartment

CIL 220E E-N
sliding hinge system

Fridge can be integrated



Aperture height: 1450 mm

CF BD2450-5EH
sliding hinge system,
incl. freezer compartment

Fridge / fridge/freezer combination can be integrated



Aperture height: 1780 mm

Fridge/freezer combination,
can be integrated

CB L3518E VW
sliding hinge system

CBT5518EW
sliding hinge system

fridge, can be integrated

CM4S518EW
sliding hinge system,
incl. freezer compartment

Dishwasher can be fully integrated



600 mm wide

CS 5C4F 0A
with sliding door

CIP 3E9E 0W

450 mm width

CDIH2L1047

CANDY



WHAT IS nolte**neo**?

Clean, minimalist lines. Exclusive fronts and fascinating details. Colours and materials that enter into harmonious dialogue and are in balance with functional design. A nolte**neo** kitchen turns a room into a statement and expresses individuality and freedom. From versatile planning options to exclusive fronts and design elements nolte**neo** opens up an entirely new dimension of customisation.

Discover nolte**neo** here!



nolte**neo** DESIGN ELEMENTS



MatrixArt ONE

is our design-focused handleless kitchen: Just one finger pull underneath the worktop, which is of course also available with illumination, creates a particularly clean graphical style. The top-most front opens on the finger pull profile, the fronts beneath are equipped with a PUSH-TO-OPEN opening mechanism. The design-focused nolte**neo** fronts with a handle recess profile is available for all carcass heights, now including the 800 mm carcass.



MatrixZERO

For a perfect addition to the new shadow reveal, there is MatrixZERO. PUSH-TO-OPEN for drawers and pull-outs is yet another excellent additional option to select with the **neo**BOX, giving you even more freedom of design for your handleless kitchen plan. The handleless nolte**neo** front division is available for all carcass heights, now also including the 800 mm carcass.



SHADOW REVEAL

Graphic and different – the 12 mm shadow reveal between front and end panel creates a completely new contour that adds a stylish designer element to every kitchen.



DESIGNER HANDLE

Above all, nolte**neo** is synonymous with the many ways of customising a kitchen. What makes this possible is a wide range of nolte**neo** products, such as the large, semi-circular handles, which, although discreetly understated, make stylish eye-catchers.

neoLEAF Sand ash
PLUS White soft mat

neoLEAF 841 - Sand ash • PLUS 601 - White soft mat
Carcase PVVD white • Worktop E42 - Sand ash
End panels SA1 - Laminate AFP, white soft mat / SE2 - Sand ash
Handle recess profile 790 - White



MatrixArt ONE



PURE ELEGANCE
WITH INGENUOUS DETAILS

A design that looks like a single piece: **neoLEAF** meets **PLUS** in white soft mat with anti-fingerprint properties. The carcass with a height of 800 mm is also available in the exclusive **nolteneo** range. In this example, **MatrixArt ONE** creates a pure, minimalist design with all the advantages of the new carcass height. The Scandinavian look gives the kitchen an elegant, restrained character that is, nevertheless, a real eye-catcher. The simple wood grain of **neoLEAF** is perfect for giving even large surfaces a wood look without making the room look too busy. Small, high-quality eye-catchers such as the wine cooler or the designer handle give this kitchen its special charm and complement the overall design.



The **neoBOX** is one of the stylish basic elements that is part of every **nolteneo** kitchen. Its narrow, lighted side frame exudes simple elegance.

The larder unit also features some special elements: The pull-out shelf **neoBOX-TAB** is colour-coordinated with the **neoBOX** and beautifully matches all other **nolteneo** interior equipment, too.



MatrixArt One is perfect for creating a tranquil, appealing gap pattern.



Watch this short video to see the advantages of T.I.O. cutlery inserts

T.I.O. (Take It Out) FULL ORGANISERS

The T.I.O. (Take It Out) interior organiser is perfectly adapted to the nolte**neo** range. In elegant black and with the marble-look base, T.I.O. fits seamlessly into the kitchen design and makes sure that everything has its place – from cutlery and spices to larger utensils. This creates a kitchen that is as beautiful as it is functional and makes everyday kitchen chores easier and more efficient.

T.I.O. ADVANTAGES AT A GLANCE

- The main cutlery element is removable
- Elegant base plate with digital print in marble design
- T.I.O. combines perfectly with accessory elements available in the Nolte range in black ash wood



FOR DRAWERS AND INTERIOR DRAWERS

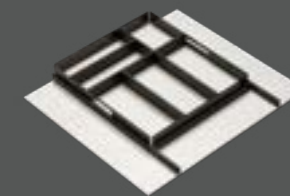

T.I.O. cutlery insert
BEI3HT ...
↔ 30/40/45/50/60/80/90/100/120*
↷ 60

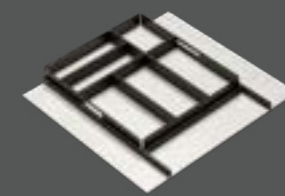

behind a side-hung door
BEI3HT60-DR
↔ 60*
↷ 60

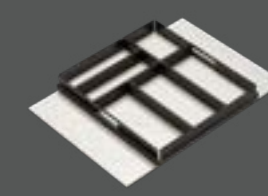

for carcass depth 50 cm
BEI3HT60-50
↔ 60*
↷ 50

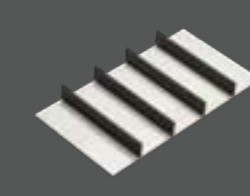

for carcass depth 39 cm
BEI3HT60-39
↔ 60
↷ 39

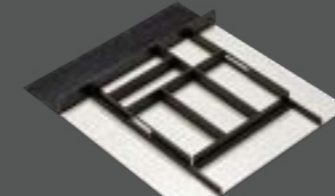

for carcass depth 75 cm
BEI3HT ...-75
↔ 60/80/90/100/120*
↷ 75

*With a removable tray element as of a carcass width of 60 cm



for hob base units
BEI3HT ...-H2
↔ 60/80/90/100/120
↷ 60

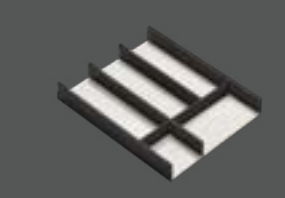

Segment cutlery insert
BEI3HT40-50-S
↔ from carcass width 40 cm
↷ 50

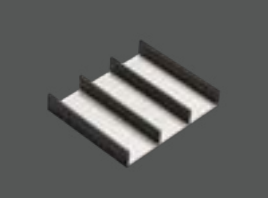

for carcass depth 39 cm
BEI3HT40-39-S
↔ from carcass width 40 cm
↷ 39

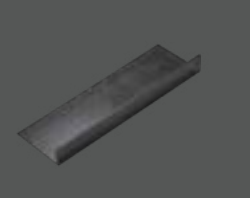

Extension element
for carcass depth 75 cm
BEI3H-60-120-TA
↔ from carcass width 30 cm
↷ 75

ACCESSORY ELEMENTS FOR T.I.O. CUTLERY INSERT

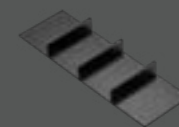

Multi-functional insert
BEI3HT-MFE
↷ 60

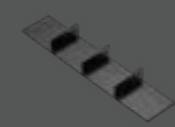

Multi-functional insert
BEI3HT-10-MFE
↷ 60

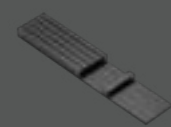

Knife block
BEI3HT-10-MES
↷ 60

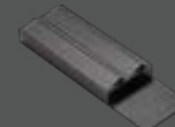

Foil unwinder
BEI3HT-FOL
↷ 60

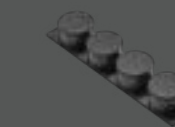

Spice insert set
BEI3HT-10-4KD
↷ 60

FOR DRAWERS AND INTERIOR PULL-OUTS

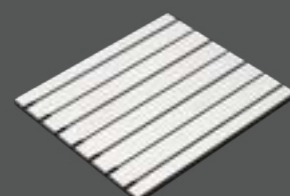

T.I.O. function base
with cross slots
AOR3HT ...-FB
↔ 60/80/90/100/120
↷ 60

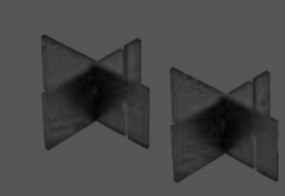

T.I.O. 2 slot-in cross dividers
suitable for the function base
AOR3-2KREUZ

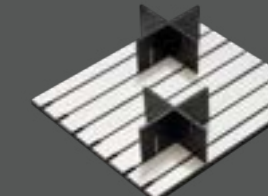

T.I.O. SET function base
with cross slots and 2 slot-in cross dividers
AOR3HT ...-FB1
↔ 60/80/90/100/120
↷ 60

Bold = image shown

↔ Carcass width

↷ Carcass depth

KITCHEN & BATHROOM – stylishly coordinated

With Nolte SPA you can give your bathroom the same appealing design as your Nolte kitchen, so that both rooms are beautifully coordinated with each other, creating a harmonious living concept. It goes without saying that NOLTE Spa offers a perfected collection of trend colours and decors. But it's the details that make all the difference. See for yourself and you will find: Nolte SPA will give you what you need to convince customers!



nolte[®]
SPA

MATRIXART
by nolte KÜCHEN

NOLTE SPA NEW FEATURES 2025

- | | | | | | |
|---|---|---|---|---|---|
| PG1
M15
MANHATTAN
Melamine resin mat | PG1
M15
MANHATTAN
Melamine resin mat | PG2
A20
ARTLINE
Melamine resin mat | PG2
V21
VELLUTO
Mat lacquer with AFP | PG2
V21
VELLUTO
Mat lacquer with AFP | PG2
V21
VELLUTO
Mat lacquer with AFP |
|---|---|---|---|---|---|



482 Lava



48T Natural oak noble mat



548 Stripe wood choco



87L Lava mat



871 White mat



87G Graphite mat



Hand basin countertops



E46 Natural oak noble mat



S08 Galaxy nero



M52 Marble bianco



M51 Marble imperiale

Carcase



LAD Lava

Handle recess profile



792 Lava

” At Nolte Küchen we combine our passion for high-quality kitchens with a profound sense of responsibility for our environment and future generations. “

Inherent throughout our entire company and its entire value chain, the guiding principle of sustainability is reflected in everything we do and the way we think. It is firmly embedded in our broad-ranging corporate strategy with a view to achieving lasting improvements for mankind and nature.

The grounds of Nolte Küchen have been home to local bees since the summer of 2023, and they have already brought in their first nectar into their hive. They not only provide delicious honey but are also indispensable pollinators, making a significant contribution to the preservation of many plant species.

OUR COMMITMENT TO ...



THE COMPANY

As a matter of good corporate governance and the associated values, we have established resilient structures, processes and partnerships over a period of many years. High quality; modern aesthetics, sustainability and an attractive price-performance ratio are the factors that are always taken into account in our product range. So, for instance, over 99% of the woods we use complies with the principles of sustainable wood criteria.



THE ENVIRONMENT

As a company, we have made it our aim to maintain a responsible and sustainable use of natural resources. Thanks to our effective climate management, we are able to manufacture our products in a climate-neutral manner at our two operating bases in Löhne and Melle. The main fuel sources at Nolte Küchen are certified green electricity and our boilers, which operate with offcut wood from production.



THE PEOPLE

Our members of staff are particularly close to our heart. Their dedication, knowledge, experience and curiosity are what define us as Nolte Küchen. For this reason, we are pleased to assist our staff in furthering their development – both on the work side through basic and further training as well as on a private level by respecting and enhancing their work-life balance.



THE SOCIETY

Ever since Nolte Küchen was first founded, we have cultivated close ties with the region, and we actively foster its well-being and growth. Social commitment is a tradition for us, and we have placed great emphasis on it from the very first day. We help people and regions in emergency situations, such as educational institutions, associations and foundations that are involved in child protection. Our credo: support is given where support is needed.



Discover the **NOLTE SUSTAINABILITY REPORT**



The kitchen is the room of rooms.
We probably *live* more,
and more *intensively*,
here than anywhere else in the home.
It is the place where
we meet, where we encounter others.
As family or friends.
As a couple.
We *cook*, *eat* and *enjoy* ourselves
in the kitchen. And sometimes we have
all the time in the world as we do so.
We argue. And *make up again*.
We read, write, send emails, post messages.
And maybe philosophise a little.
And – quite secretly – the kitchen sets
the rhythm of our day.
Good morning. Then midday. Then evening.
And sometimes night ...
Which is *why we love* the kitchen.

Living in the kitchen. nolte

VF-NP25-GB

Subject to technical change without notice. Colour shades shown in this catalogue may sometimes vary slightly from original colours for printing and photographic reasons.

Nolte Küchen GmbH & Co. KG | Anni-Nolte-Straße 4 | 32584 Löhne
www.nolte-kuechen.com



nolte[®]
KÜCHEN